

Instructions for the Installation and Operation of RCA UHF-TV Klystrons

This Note provides necessary information for the proper installation and operation of three RCA large-power klystrons designed to cover the frequency range from 470 to 890 MHz. The RCA-8824 operates at frequencies from 470 to 566 MHz, the 8825 from 566 to 698 MHz, and the 8826 from 698 to 890 MHz. Maximum ratings and outline dimensions for each type are given in the respective technical bulletin. Performance data, obtained during factory testing, accompanies each tube.

The tube bulletin and the specific performance data should be reviewed, together with this Note and the "RCA Application Guide 1CE-279A" before the tube is installed or operated. Requests for the publications described or for application assistance, should be addressed to RCA Large-Power Application Engineering, Lancaster, PA 17604.

Precautions

Because the dc voltages and rf radiations present during klystron operation are potentially dangerous to personnel, certain safety precautions are required. These safety measures include high-voltage screens, voltage interlocks, tight rf connections and shielded rf terminals. **This device, in operation, may produce X-radiation which can constitute a health hazard. Shielding or other precautions may be required.**

Uncrating

Each RCA UHF-TV Klystron is shipped in a sturdy wood crate designed for forklift use. A shock-mounted, welded-steel frame supports and protects the tube on special tracks during shipping and storage. Care must be used during uncrating to prevent any object from striking the tube, especially the electron gun, collector, rf connectors, or water fittings.

In addition, the ceramic parts must be kept clean. If these parts become contaminated by finger prints or the like, they

should be washed with a solution of distilled water and detergent, wiped with a dust-free cloth, rinsed with acetone or methanol, and dried thoroughly.

WARNING: Acetone and methanol are inflammable and explosive. They should be used only in an adequately ventilated area. Avoid inhalation of these vapors.

The specific instructions for uncrating and recrating these klystrons are attached just inside the lid of the shipping crate. They should be reviewed thoroughly after the top of the crate is removed and before proceeding with the actual removal of the klystron from the crate. These instructions should be retained, together with all hardware and braces removed during uncrating, for use in future recrating, storage or shipping.

Crate-to-Socket Transfer

A cart with tracks similar to those in the shipping crate is recommended for transferring the klystron from the crate to its operating socket. Other methods of transfer may be used if desired. RCA Large-Power Application Engineering, Lancaster, PA may be contacted for recommended cart designs and alternate transfer methods.

When a transfer cart is used, it is rolled up to the crate, both sets of tracks are aligned, and the cart is then fixed in position so that it cannot move. The klystron is then rolled from the crate to the cart. It is important that the tube rollers engage properly in the cart tracks.

For easy transfer of the klystron tube from the cart to its electromagnet at the transmitter, it is recommended that some means be provided for tilting the electromagnet to a horizontal position. Once the tube is seated in the electromagnet, the cart can be removed and the electromagnet rotated to the vertical position for normal operation.

It may be more convenient and economical in some applications to incorporate the electromagnet as part of the klystron transfer cart.

Connections

Basic tube connections are described in detail in the General Data section of the klystron technical bulletin. Connections requiring special consideration are discussed below.

It is recommended that finger stock be used for making contacts to the modulating-anode, heater-cathode, and heater terminals of the klystron. The finger stock must be capable of carrying the maximum current specified in the klystron data sheet. It is recommended that the finger stock contacts be mounted so that the connection to the tube terminal is made automatically when the tube and electromagnet are rotated to the vertical operating position.

A flexible steam jacket (sleeve) made of neoprene or an equivalent material is recommended for the connection between the upper end of the tube and the water-vapor cooling system. The jacket is placed over the lip provided at the top of the boiler and clamped securely in place for a steam tight connection.

A separable, coaxial adapter is used with the RCA-8824 and 8825 klystrons. The adapter for the RCA-8826 klystron is an integral unit and is built into the klystron at the factory.

Before the RCA-8824 or 8825 klystron can be placed in operation, it is necessary to attach its coaxial adapter which is packaged and secured to the inside of the klystron shipping crate. The following items must be checked before the connection is started.

1. The serial number of the coaxial output adapter must match that of the klystron. Never interchange output adapters between klystrons since each is electrically matched at the factory.
2. The spring contacts at each end of the center conductor of the adapter must be undamaged and properly seated.
3. The two sections of the center conductor, which join at the insulated spacer, must be screwed tightly together.
4. The threads of the adapter and the mating threads on the klystron output coaxial port must be clean and free of grit.

The output adapter is attached by centering it on the klystron window and exerting a slight inward pressure while, at the same time, rotating it clockwise to mate its threads with those of the klystron output. Continue to rotate the adapter slowly until it is firmly seated against the mating klystron contact surface. Force should be limited to hand pressure only.

Connection to the rf output terminal of the adapter is made by means of a standard 3-1/8 inch EIA coaxial transmission

line section as shown in the tube bulletin. The center conductor of the adapter is connected to the center conductor of the transmission line by means of the spring contacts on the adapter. The outer conductors are connected via a slotted outside sleeve and the sleeve is secured to the OD of the adapter and transmission line by a pair of worm-driven adjustable clamps. When making this connection, it is extremely important that the center conductor of the transmission line fully engages the spring contacts of the adapter center conductor. It is recommended that the center conductor of the output adapter for the RCA-8824 and 8825 be rotated slightly clockwise while making the connection of the transmission line to the adapter in order to facilitate mating the spring contact and the ID of the center conductor. This can be accomplished through an access hole provided at the first elbow of the transmission line, by inserting a special, 9/64" hex key on an extension, into the access hole and engaging the socket-head cap screw which holds the two halves of the output adapter center conductor. The extension must be of sufficient length to reach the cap screw.

WARNING: The center conductor of the RCA 8824 or 8825 klystron output adapter should never be rotated counter-clockwise, since this action may loosen the screw that joins the two output adapter center conductors. A loose joint between the center conductors may ultimately result in a high VSWR and klystron output-window failure.

The center conductor of the RCA 8826 cannot rotate. It is pressed directly into the transmission line center conductor.

When the transmission line is properly attached to the adapter, the end of the transmission line outer conductor will butt against the end of the adapter center conductor. The butt joint should be verified by visual inspection through the slots in the outside sleeve. The sleeve should then be secured to the adapter and transmission line outer conductors by tightening the adjustable clamps.

IMPORTANT: Improper connection of the transmission line to the coaxial output adapter may cause the destruction of the tube during operation.

Protection Considerations

Normal protection considerations for RCA klystrons are discussed in the Application Guide 1CE-279. All protection devices should be thoroughly tested before operating a klystron in the transmitter to avoid severe damage to and possible loss of a tube. A protection system, shown in Figure 1, is recommended specifically for these klystron tubes and it includes:

1. Interlocks to interrupt the klystron beam and the modulating-anode voltage in the event of any of the following conditions:
 - (a) Opening or removal of access doors and/or high voltage shield.

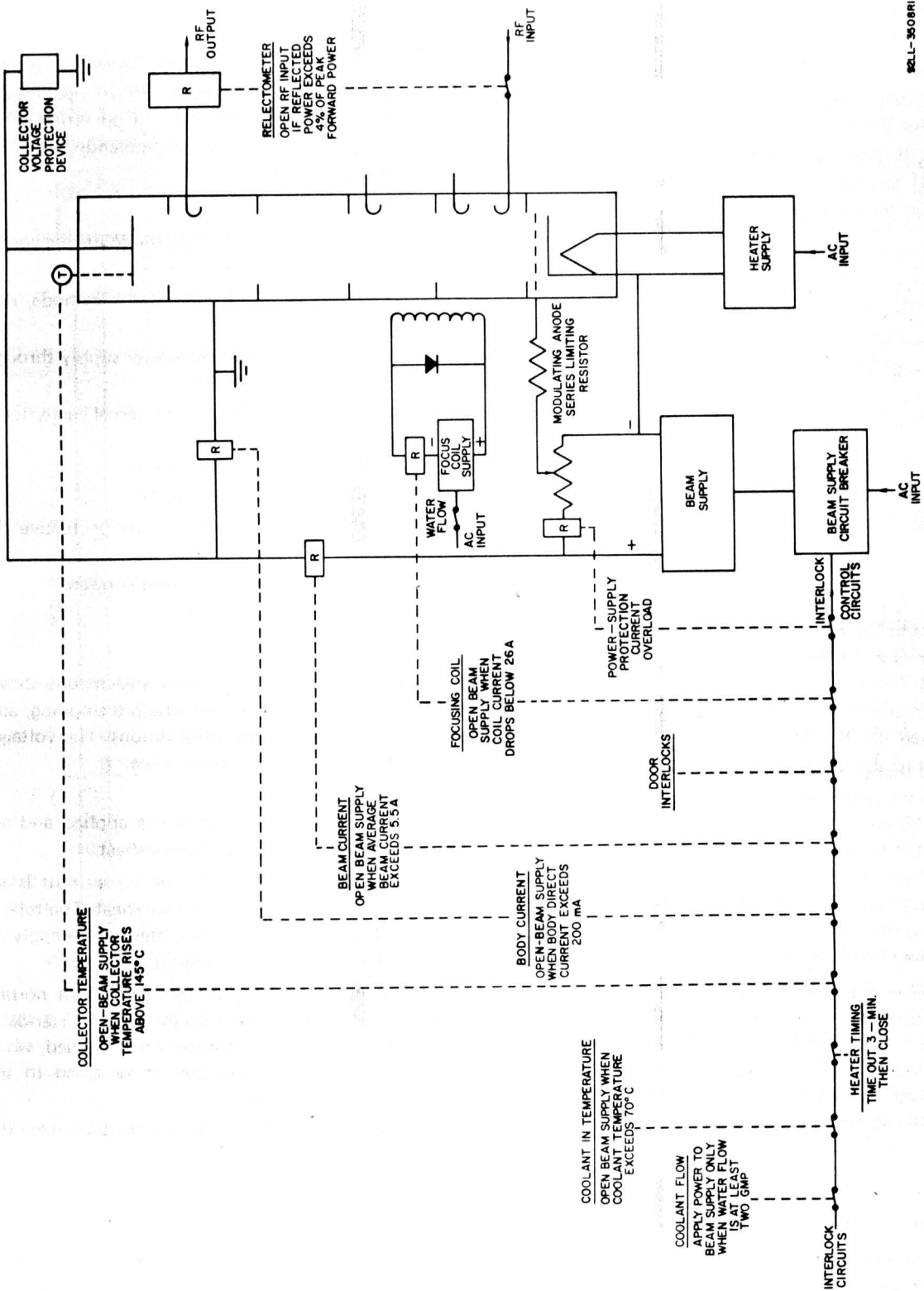

92L-3608RI

Figure 1 - Typical Basic Protection Circuits Functional Diagram

- (b) Insufficient klystron coolant flow
 - (c) Klystron beam overcurrent
 - (d) Klystron body overcurrent
 - (e) Excess klystron collector temperature
 - (f) Excess klystron coolant-inlet temperature
 - (g) Insufficient electromagnet excitation
2. An interlock to prevent the application of the klystron-beam or modulating-anode voltage until sufficient time has elapsed for filament warm-up
 3. An interlock to interrupt the rf drive to the klystron in the event of an excessive voltage standing-wave ratio (VSWR) in the output coaxial system.

In addition, a "Thyrector" or other similar protective device should be connected between the collector and ground to protect personnel and collector circuits against high voltage in case of faulty collector-return circuitry.

Under normal conditions, the potential difference between the collector and the tube body is negligible. However, in the event of a collector open circuit, it is possible for the collector to charge to a high negative voltage. Therefore, protection is recommended to prevent contact with the collector when the beam or modulating-anode voltage is on.

Cooling

Three cooling systems are required for the operation of the klystron, i.e.; water vapor for the collector section, water for the body section of the tube, and forced-air for the electron-gun section. Information on pressure and temperature requirements is given in the klystron technical bulletin.

It is recommended that distilled water be used in the water-vapor system. This water should have a total foreign residue of not more than 50 parts per million. No anti-freeze mixture should be added to the coolant. If precautions against freezing must be taken, it is suggested that electric heaters be provided. A simplified, typical water-vapor cooling-system flow diagram is shown in Figure 2. Only stainless steel or brass fixtures should be used in the system.

The heat exchanger may be operated by either air or water flow. Whichever is used, the design must be compatible with the system temperature and flow requirements given in the tube bulletin. In either case, the heat-exchanger support must be strong, level, and of the proper height to permit water flow from the steam-condensing outlets on the heat exchanger to the storage tank. The steam path must be as direct as possible to prevent back-pressure buildup. The steam pipes must be sloped so that the condensed water flows into the heat exchanger and not back into the boiler.

The water level must be maintained above the top of the collector heat dissipator but below the rim of the steam-

exhaust outlet. A Weir system, as shown in Figure 2, assures this condition. Care should be observed during installation of the system to prevent foreign matter such as solder flux, pipe "dope", metal chips, and the like from entering the water-vapor cooling system.

Klystron "Break-In" Operation

It is recommended that the klystron "Break-In" procedure be performed immediately prior to the initial operation. Subsequently, if the tube has been out of operation for a period in excess of seven days, it is recommended that the "Break-In" procedure be repeated.

Before voltages are applied to the tube, the following conditions should be checked:

1. Proper connections of the heater, heater-cathode, and modulating anode.
2. Connection of the collector to the power supply through appropriate protective devices.
3. Connection of the 50 ohm, 50 watt, external cavity load when specified.
4. Ground connections properly secured.
5. Correctly functioning coolant systems.
6. Operation of the arc and reflected-power protective circuitry.
7. Direction and operation of the electron-gun fan.

The test performance sheet shipped with each tube shows the results of tests made on the tube before shipping, and gives the recommended operating conditions. The voltages should be applied in the following sequence.

1. The electromagnet focusing voltage is applied and adjusted as specified on the performance sheet.
2. The heater power is applied. The heater current is adjusted as specified on the performance sheet. The tube is allowed to warm up for thirty minutes before applying beam voltage during the "Break-In" procedure.
3. Reduced beam voltage (approximately 60% of normal operating voltage as obtained by means of a star-delta switching or high voltage transformer) is applied; when conditions are stable this voltage is increased to the recommended operating value.
4. RF drive is applied and the drive level is adjusted for the required rf output.

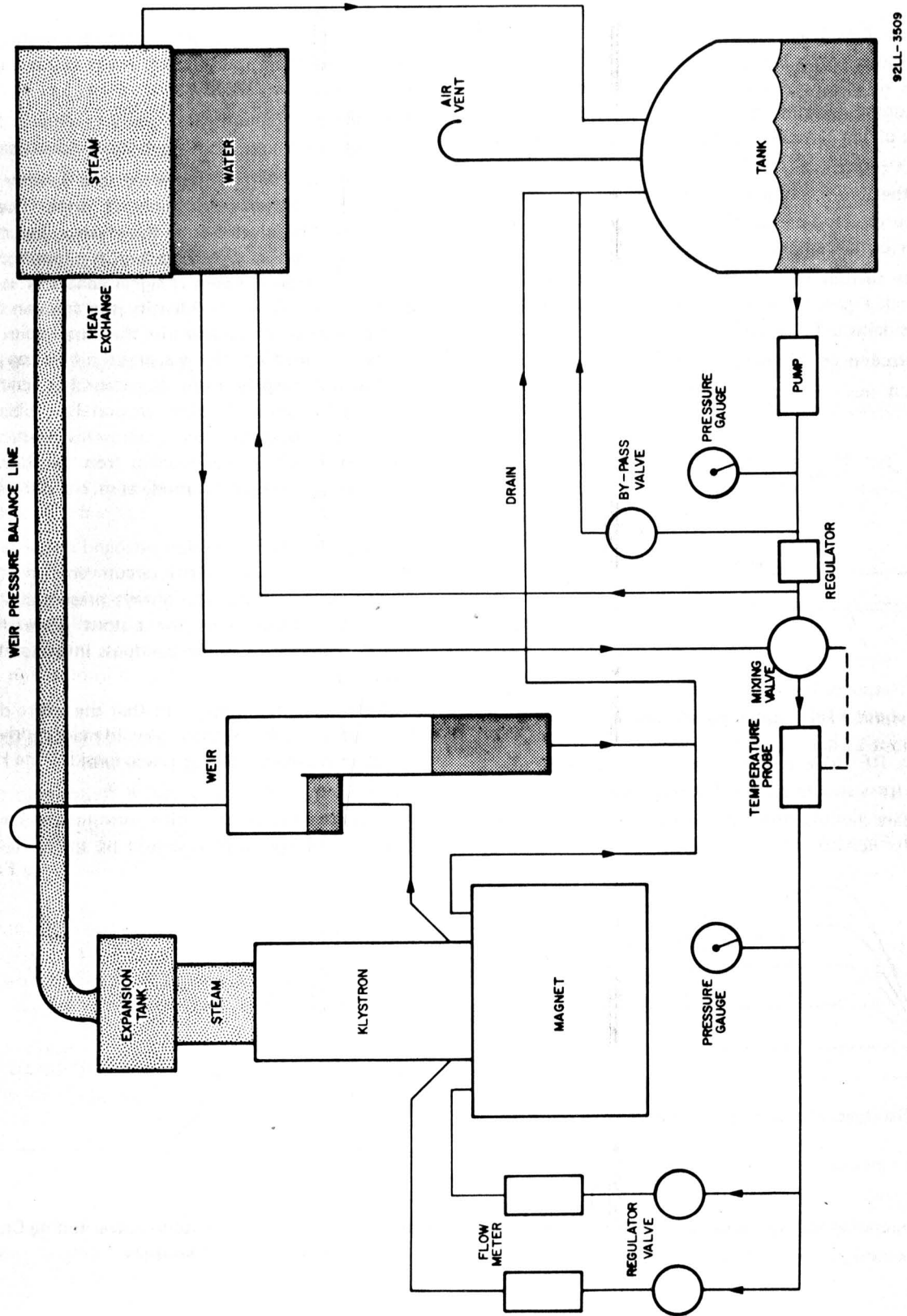

Figure 2 -- Water-Vapor Cooling System Flow Diagram

Klystron Tuning

Each UHF-TV Klystron is tested at the factory and pretuned for visual service to the frequency specified by the customer.

Visual Service, Fine Tuning

Although each klystron is factory tuned for optimum performance in visual color-TV service, it may be desirable to make fine tuning adjustments in order to enhance the overall response of the television transmitter. The procedure is as follows:

1. Adjust the beam voltage, modulating-anode voltage, magnet current and heater current to the values specified in the Performance Sheet.
2. Fine tune cavities Nos. 1, 2 and 3 for a smooth bandpass. Check **Figure 3** for proper response for the normal vestigial sideband TV signal.

Cavity No.4 must be tuned to the visual carrier frequency.

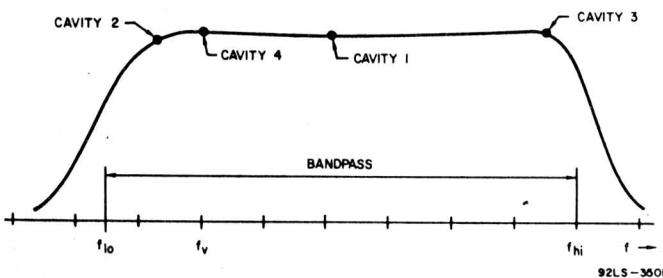

Figure 3 — Response Presentation after Tuning Cavity 1 to about 2 MHz above F_v and fine tune other cavities

3. Vary the RF drive between white and blanking level. The bandpass should remain flat but show enhancement in the carrier vicinity with higher output power in accordance with **Figure 4**.

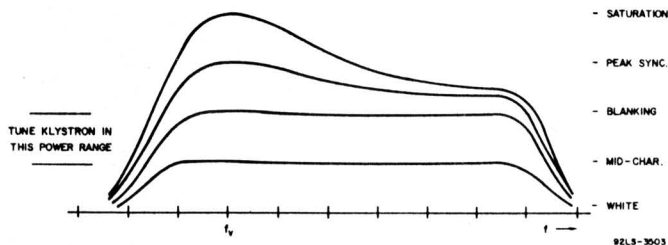

Figure 4 — Bandpass at various power levels

4. Adjust magnet current for minimum klystron body current.
5. Log all operating voltages and currents for future reference.

Retuning From Aural to Visual Service

If the klystron is to be operated as a visual amplifier after being used in aural service on the same channel, the procedure is as follows:

1. Adjust beam voltage, modulating-anode voltage, magnet current and heater current to the values given in the Performance Sheet.
2. Tune the 3rd (penultimate) cavity to a higher frequency than the carrier frequency (two turns clockwise).
3. With the tube output connected to a dummy load (bypassing the filterplexer) apply rf drive. The rf drive source must be isolated from the klystron input to insure against changes in driver loading. A circulator is a convenient isolator. A swept rf signal generator can be used as the driver. Carefully identify the frequencies of the crystal markers and make sure that the klystron output cavity is tuned to the visual carrier frequency. The oscilloscope display must be accurately calibrated in terms of the sampled output power. This is best accomplished by comparing the oscilloscope deflection with the calorimetric power reading from the dummy load while operating in the CW mode at several different power levels.

The use of a UHF television sideband response analyzer, RCA BWU-5 or equivalent circumvents most of these calibration problems. The always present carrier allows constant monitoring of the output power while the swept sidebands carry the bandpass information (= 20% modulation).

In both cases, it is important that the entire drive chain have sufficient bandwidth to avoid masking the klystron behavior during the tuning procedure.

4. Tune cavities 1(input), 2 and 4 (output) to the carrier frequency. Reduce the drive level to avoid saturation. The oscilloscope display should be similar to **Figure 5**.

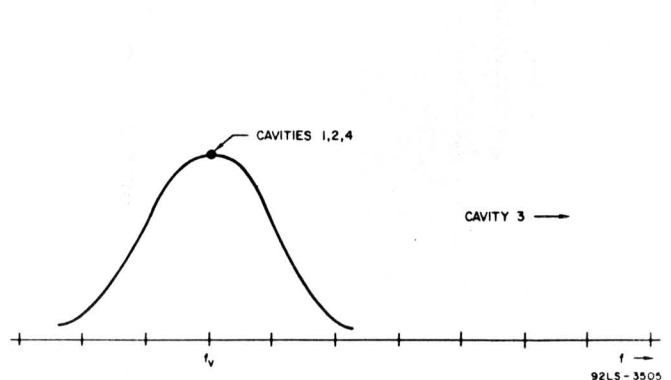

Figure 5 — Response Presentation after tuning Cavities 1, 2, 4 to carrier frequency

5. Tune cavity 3 lower in frequency (counterclockwise) until its peak appears on the screen at a point about 0.5 MHz below the upper end of the desired bandpass as shown in Figure 6. Adjust drive level if necessary.

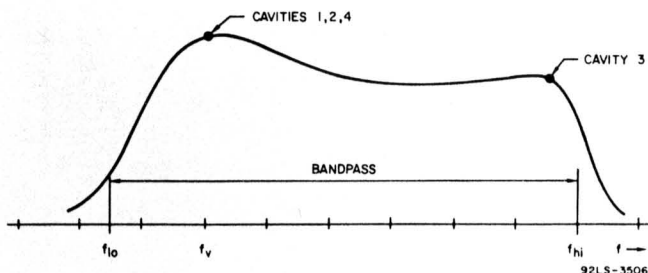

Figure 6 — Response Presentation after Tuning Cavity 3 to 0.5 MHz below F_{hi}

6. Tune cavity 2 lower in frequency (counterclockwise) to a frequency which is approximately 0.5 MHz higher than the low end of the desired bandpass. See Figure 7.

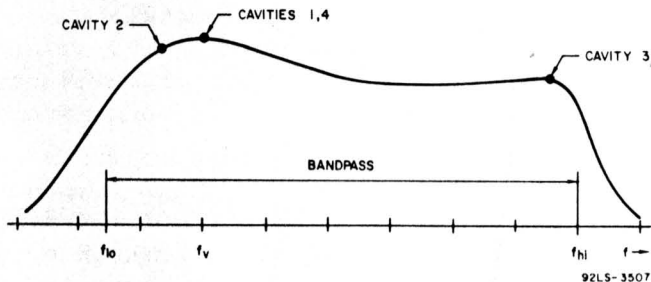

Figure 7 — Response Presentation after Tuning Cavity 2 to 0.5 MHz above F_{lo}

7. Tune the input cavity (1st) higher in frequency (clockwise) until the bandpass roughly has the desired shape as shown in Figure 3. Make sure that the output power corresponds to the blanking level or less and adjust the rf drive, accordingly.

To assure optimum performance continue as follows:

8. Fine tune cavities 1, 2 and 3 for a smooth bandpass. Check Figure 3 to find the areas of the response curve affected by the individual cavities. This is the proper response for the normal vestigial sideband TV signal.
9. The bandpass should remain flat with varying rf drive between white and blanking level but will show an enhancement in the carrier vicinity with higher output power as shown in Figure 4.

10. Adjust the magnet current for minimum klystron body current.
11. Log all operating voltages and currents for future reference.

Aural Service

If it is desired to retune a UHF-TV Klystron for aural service on the same channel for which it has been operating in visual service, proceed as follows:

1. Adjust beam, modulating-anode voltage, and magnet current to normal values for aural service. While the beam voltage usually is given by the requirements of the visual tube using the same power supply, the modulating anode voltage is dropped for aural operation to produce a lower beam current.
2. Tune the 3rd cavity to a higher frequency than the carrier (two turns clockwise).
3. Apply rf drive at the aural carrier frequency and tune cavities 1, 2 and 4 for maximum power output.
4. Tune cavity 3 lower in frequency for maximum power output. Note: There are two maximums; one with the third cavity tuned on either side of the carrier frequency. For proper operation keep the third cavity tuned above the carrier frequency.
5. Adjust the aural rf drive and/or the modulating-anode voltage for the desired output power.
6. Adjust the magnet current for minimum klystron body current and retune cavity 3 slightly higher in frequency (clockwise).
7. Log all operating voltages and currents.

Storage

During storage, the tube must be protected from moisture and extreme temperature changes. As a safeguard, it is recommended that tube be stored in the shipping container in the manner in which it was received. Before a tube is shipped or placed in storage, all the coolant should be poured from the cooling ducts, and the ducts blown free of any remaining coolant. This precaution is imperative when the coolant is water to prevent the voltaic action in the ducts which might cause corrosion and also the possibility of water freezing in the ducts if the surrounding temperature drops below 0°C (32°F). Care should be taken to prevent any foreign matter from entering the coolant connections; it is recommended that coolant connections be covered with Pliofilm, or other suitable material, during storage.